

2 0 1 7
CATALOG
HUNTING AND
DEFENSE FIREARMS



LA MANUFACTURE

Verney-Carron



EPV
Entreprise
du Patrimoine
Vivant



1^{er} FABRICANT FRANCAIS
D'ARMES DE CHASSE

SMOOTH BARREL GUNS

RIFLED BARREL GUNS

NEW

Véloce Manual repeating shotguns **Véloce**

Sagittaire Aquilon Over & under shotguns **Sagittaire**

SagittaireXS XS20 Over & under shotguns **SagittaireXS**

V12N Gas operated semi-automatic shotguns **V12N**

Matrix Plaine Inertia semi-automatic shotguns **MATRIX®**

SOLO 410 Single barrel shotguns **SOLO** BY VERNEY-CARRON

NEW

Juxtaposé VerCar Canardouze Reasonably priced shotguns **VERCAR**

P12 BlackCrow Riffed pump action shotguns **P12**

NEW

SpeedLine Gator Manual repeating rifles **SPEEDLINE**

NEW

Impact LA Fusion Linear reloading rifles **IMPACT LA**

NEW

Impact NT Bête Noire Semi-automatic rifles **IMPACT NT**

Sagittaire Express One Over and under rifles **Sagittaire**

Sagittaire Gros Gibier One «Slug» over and under shotgun **Sagittaire**

SagittaireXS eXS Over and under rifles **SagittaireXS**



Master the speed, optimize your instinct...

Shoulder the Vélocé, lastborn from the partnership of our R&D department and the NOVAM design laboratory from Saint-Etienne.

This new kind of manual repeating shotgun, developed in order to fulfill the wishes of the most demanding, will bring you into history. **It's up to you to work the lever...**

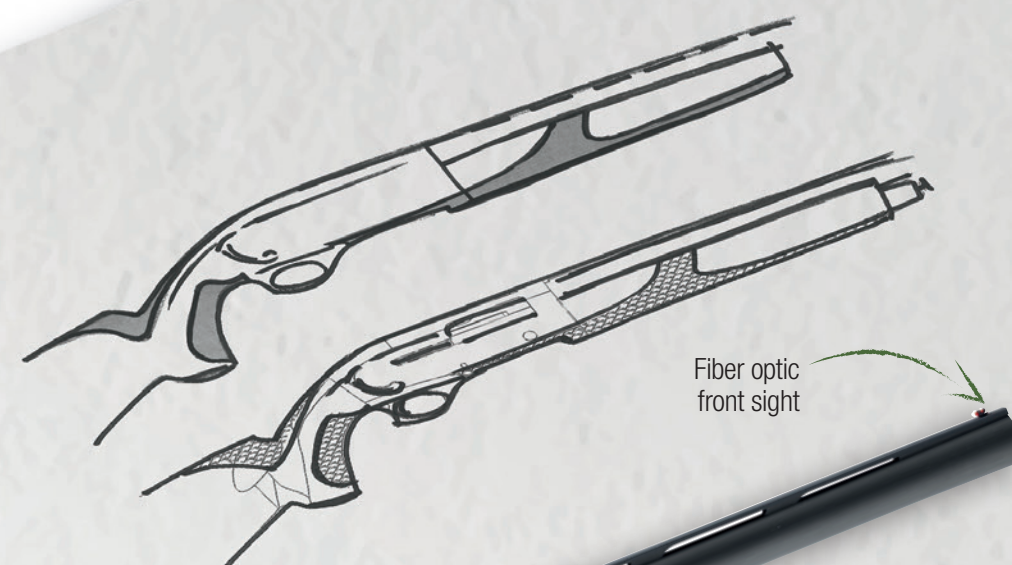

NEW

71 cm barrel, chrome molybdenum «Super Diamond» steel with 5 interchangeable chokes.



RECEIVER WITH RAIL ON THE TOP COMPATIBLE WITH MOST OF THE MOUNTS AVAILABLE ON THE MARKET



VELOCE
Ref. VL12CX71

STOP & GO

The patented « Stop&Go® » system allows an unequalled rate of fire on a manual repeating shotgun by locking the bolt to the rear after automatic ejection of the fired shells. The reloading is achieved by a light pressure on the lever.

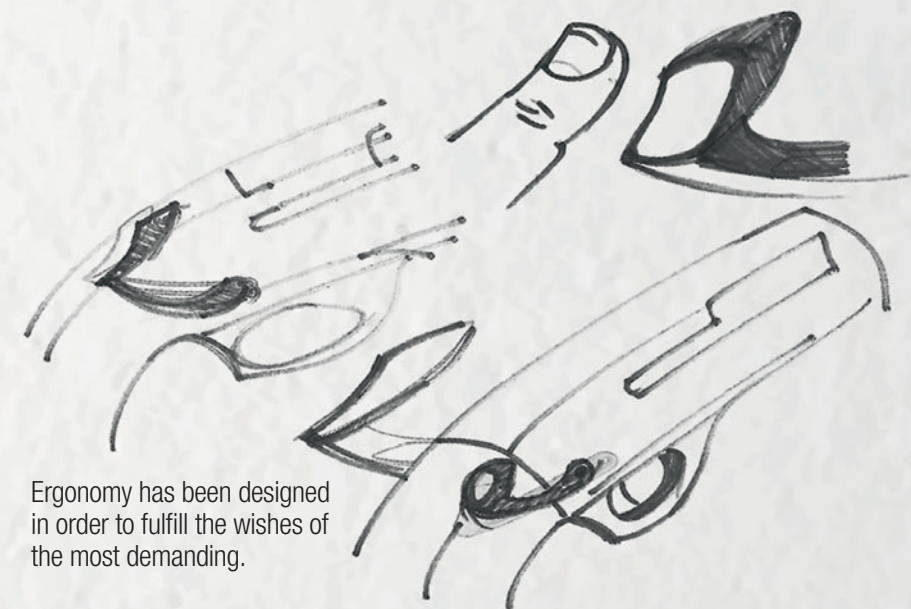

Ergonomy has been designed in order to fulfill the wishes of the most demanding.

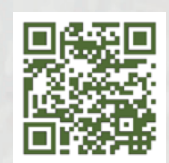

Specifications

- GAUGE: Magnum 12
- TOTAL LENGTH : 123 cm
- WEIGHT: 3,150 kg
- BARREL:
 - 71 cm, chrome molybdenum «Super Diamond» steel.
 - Interchangeable chokes
- RECEIVER
 - Rail on the top compatible with most of the mounts available on the market
 - In Ergal, high sturdiness, black anodized.
- WOOD: 3 stars oiled-finished walnut with ultra-ergonomic checkering
- EJECTION : automatic
- SIGHTING SYSTEM : 8mm ventilated rib and fiber optic front sight
- MAGAZINE TUBE : 5 + 1
- SLING SWIVELS : supplied and installed



Supplied with a case and 5 interchangeable chokes, from cylindrical to Full choke.

Options

- Magazine tube extender
- 5 cm barrel extender with interchangeable chokes



YOU WILL LIKE

First Sagittaire with **71 cm barrels** and interchangeable chokes.



SAGITTAIRE® AQUILON CLASSIQUE

Ref. **242CX71AQ** (extractor - Ergal receiver)
 Ref. **242CX71MAQ** (extractor - steel receiver)
 Ref. **252CX71AQ** (automatic ejectors - Ergal receiver)
 Ref. **252CX71MAQ** (automatic ejectors - steel receiver)



SAGITTAIRE® AQUILON EXTRA-LUXE

Ref. **262CX71AQ** (extractor - Ergal receiver)
 Ref. **262CX71MAQ** (extractor - steel receiver)
 Ref. **272CX71AQ** (automatic ejectors - Ergal receiver)
 Ref. **272CX71MAQ** (automatic ejectors - steel receiver)



«Duck» pistol grip cap
 More caps see p. 26



SAGITTAIRE® AQUILON SAINT-HUBERT

Ref. **262CX71AQSH** (extractor - Ergal receiver)
 Ref. **262CX71MAQSH** (extractor - steel receiver)
 Ref. **272CX71AQSH** (automatic ejectors - Ergal receiver)
 Ref. **272CX71MAQSH** (automatic ejectors - steel receiver)



SAGITTAIRE POLYNOX® ONE

Only available with extractor and Ergal receiver. Supplied with only 3 chokes. Mat barrel finish.

Ref. **242CXONE68P** («classic» double triggers)
 Ref. **241CXONE68P** (single trigger)



SAGITTAIRE POLYNOX® CLASSIQUE

Ref. **242CX68P** (extractor - Ergal receiver)
 Ref. **242CX68MP** (extractor - steel receiver)
 Ref. **252CX68P** (automatic ejectors - Ergal receiver)
 Ref. **252CX68MP** (automatic ejectors - steel receiver)



SAGITTAIRE POLYNOX® EXTRA-LUXE

Ref. **262CX68P** (extractor - Ergal receiver)
 Ref. **262CX68MP** (extractor - steel receiver)
 Ref. **272CX68P** (automatic ejectors - Ergal receiver)
 Ref. **272CX68MP** (automatic ejectors - steel receiver)



«Duck» pistol grip cap
 More caps see p. 26



SAGITTAIRE POLYNOX® SAINT-HUBERT

Ref. **262CX68PSH** (extractor - Ergal receiver)
 Ref. **262CX68MPSH** (extractor - steel receiver)
 Ref. **272CX68PSH** (automatic ejectors - Ergal receiver)
 Ref. **272CX68MPSH** (automatic ejectors - steel receiver)

➤ Specifications

- CALIBER: Magnum 12 gauge
- TOTAL LENGTH: 115 cm
- WEIGHT: 2,700 kg (Ergal receiver) or 3 kg (steel receiver)
- BARRELS:
 - 71 cm, Chrome molybdenum cold-forged «Super Diamond» steel
 - Special slim interchangeable Chokes for the Aquilon
- TRIGGER: double with dual-action front trigger (or single trigger on request)
- LOCKING: by 2 conical bolts
- RECEIVER: steel or forged Ergal

- WOOD: oil-finished walnut
 - Stock: pistol grip (or English stock at extra charge)
 - Forend: full
- EJECTION: extractor or automatic ejectors with extremely powerful hammers
- SIGHTING SYSTEM: 7 mm ventilated rib
- PERCUSSION: axial and direct
- SLING SWIVELS: supplied



Supplied with gun case and 3 interchangeable chokes - 1/4, 1/2 and full.

➤ Options

- Custom stock measurements on request
- Modified stock for left-handed
- English stock available at extra charge
- Full cross-over stock (to aim with left eye while shouldering on the right)
- Interchangeable chokes from cylindrical to Extra choke special for Aquilon mode
- Additional set of barrels
- Custom possibilities:
 - your name on the barrel
 - your initials on the trigger guard

➤ Specifications

- CALIBER: Magnum 12 gauge
- TOTAL LENGTH: 112 cm (with internal chokes)
- WEIGHT: 2,700 kg (Ergal receiver) or 3 kg (steel receiver)
- BARRELS:
 - 68 cm, Chrome molybdenum cold-forged «super diamond» steel
 - Interchangeable Chokinox® chokes (internal, long et extra long) lengthening the barrels of 3 or 5 cm
- TRIGGER: double with dual-action front trigger (or single trigger on request)
- LOCKING: by 2 conical bolts

- RECEIVER: Steel or forged Ergal
- WOOD: oil-finished walnut
 - Stock : pistol grip (or English at extra charge)
 - Forend : full
- EJECTION: extractor or automatic ejectors with extremely powerful hammers (except Polynox One)
- SIGHTING SYSTEM: 7mm ventilated rib
- PERCUSSION: axial and direct
- SLING SWIVELS: supplied

➤ Options

- Custom stock measurements on request
- Modified stock for left-handed
- English stock available at extra charge
- Full cross-over stock (to aim with left eye while shouldering on the right)
- Interchangeable Chokinox® chokes
 - Internal
 - Long (+3 cm)
 - Extra Long (+5 cm)
- Additional set of barrels
- Custom possibilities:
 - your name on the barrel
 - your initials on the trigger guard



Over and under shotguns Sagittaire GRAND BECASSIER



Over and under shotguns Sagittaire ULTRA LÉGER, SPÉCIAL PALOMBE & LA BILLEBAUDE



STEEL SHOT
PROOF TESTED

LIGHTWEIGHT
AROUND
2,400 kg

SAGITTAIRE GRAND BECASSIER CLASSIQUE
Ref. 242RI60PGB



STEEL SHOT
PROOF TESTED

LIGHTWEIGHT
AROUND
2,400 kg

SAGITTAIRE GRAND BECASSIER EXTRA-LUXE
Ref. 262RI60PGB



STEEL SHOT
PROOF TESTED

LIGHTWEIGHT
AROUND
2,400 kg

SAGITTAIRE GRAND BECASSIER MORDOREE
Ref. 262RI60PGBSH



«Woodcock» pistol grip cap
More caps see p. 26

YOU WILL LIKE

- Even lighter : 2,4 kg
- Barrel without ventilated rib
- Supplied with gun case
- Incredibly effective!

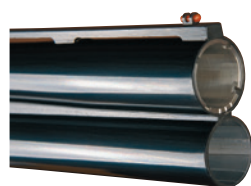

Lower barrel with Verney-Carron extra-spread rifling



STEEL SHOT
PROOF TESTED

LIGHTWEIGHT
AROUND
2,480 kg

SAGITTAIRE ULTRA LEGER CLASSIQUE
Ref. 262CX66PUL

YOU WILL LIKE ULTRA LEGER

An extremely refined 12 gauge shotgun with the exceptional Sagittaire over and under shotgun characteristics, the perfect choice for all hunters who walk long distances, thanks to its ultra-light weight, **less than 2.5 kg !**



SAGITTAIRE SPÉCIAL PALOMBE
Ref. 242TE76MP

YOU WILL LIKE SPÉCIAL PALOMBE

11 mm ventilated steel milled rib



STEEL SHOT
PROOF TESTED

LIGHTWEIGHT
AROUND
2,500 kg

SAGITTAIRE LA BILLEBAUDE CLASSIQUE
Ref. 242CX60P

YOU WILL LIKE LA BILLEBAUDE

Supplied with gun case and 6 interchangeable Chokinox® chokes.



2 «Internal» chokes: Cylinder and 1/2 choke 2 «Extra-Long» chokes: Rifled and 1/2 choke 2 «+10 cm» chokes: 1/4 choke, 1/2 choke or 3/4 choke

Specifications

- CALIBER : 12 gauge
- TOTAL LENGTH: 104 cm
- WEIGHT: 2,400 kg
- CANONS :
 - 60 cm, Chrome molybdenum cold-forged «Super Diamond» steel
 - Lower barrel with Verney-Carron extra spread rifling and upper barrel with interchangeable chokes Chokinox® (cylinder lower barrel on request)
- TRIGGER: double with dual-action front trigger (or single trigger on request)
- LOCKING: by 2 conical bolts
- RECEIVER: forged Ergal

- WOOD: oil-finished walnut
 - Stock : pistol grip (or English at extra charge)
 - Forend : full
- EJECTION: extractor (or automatic ejectors on request and at extra charge)
- SIGHTING SYSTEM: without ventilated rib
- PERCUSSION: axial and direct
- SLING SWIVELS: supplied



Supplied with gun case and 2 interchangeable chokes Chokinox® : cylinder and 1/2

Options

- Custom stock measurements on request
- Modified stock for left-handed
- English stock available at extra charge
- Full cross-over stock (to aim with left eye while shouldering on the right)
- Additional set of barrels
- Custom possibilities:
 - your name on the barrel
 - your initials on the trigger guard

Specifications

- GAUGE : Magnum 12
- TOTAL LENGTH : 110 cm (Ultra Léger), 120 cm (Spécial Palombe), 104 cm (La Billebaude)
- WEIGHT : 2,480 kg (Ultra Léger), 3,250 kg (Spécial Palombe), 2,500 kg (La Billebaude)
- BARRELS :
 - Chrome molybdenum cold-hammered «Super Diamond» steel. Length : 66 cm (Ultra Léger), 76 cm (Spécial Palombe), 60 cm (La Billebaude)
 - Chokes : Interchangeable chokinox chokes 1/4, 1/2 and full (Ultra Léger), Fixed chokes 3/4 and extra choke (Spécial Palombe), 6 interchangeable Chokinox® chokes (La Billebaude)
- RECEIVER : forged Ergal (Ultra Léger and La Billebaude), steel (Spécial Palombe)

- TRIGGER : double with first dual action trigger (or single trigger on request)
- LOCKING : by 2 conical bolts
- WOOD : oil-finished walnut
 - Stock : pistol (or English at extra charge)
 - Forend : full
- EJECTION : extractor (or automatic ejectors on request and at extra charge)
- SIGHTING SYSTEM : 7mm ventilated rib (Ultra Léger), 11mm ventilated milled rib (Spécial Palombe), 7mm ventilated rib with luminous rear sight (2 green points) and fiber optic front sight (La Billebaude)
- PERCUSSION : axial and direct
- SLING SWIVELS : supplied

Options

- Custom stock measurements on request
- Modified stock for left-handed
- English stock available at extra charge
- Full cross-over stock (to aim with left eye while shouldering on the right)
- Interchangeable Chokinox® chokes
 - Internal
 - Long (+3 cm)
 - Extra Long (+5 cm)
- Additional set of barrels
- Custom possibilities:
 - your name on the barrel
 - your initials on the trigger guard



Over and under shotguns Sagittaire^{XS} XS20 PLAINE

Pump action shotguns



STEEL SHOT
PROOF TESTED

LIGHTWEIGHT
AROUND
2,600 kg

SAGITTAIREXS XS20 PLAINE CLASSIQUE

Ref. 242XS20CX71 (extractor)
Ref. 252XS20CX71 (automatic ejectors)



STEEL SHOT
PROOF TESTED

LIGHTWEIGHT
AROUND
2,600 kg

SAGITTAIREXS XS20 PLAINE EXTRA-LUXE

Ref. 262XS20CX71 (extractor)
Ref. 272XS20CX71 (automatic ejectors)



Over and under shotguns Sagittaire^{XS} XS20 BÉCASSIER



STEEL SHOT
PROOF TESTED

LIGHTWEIGHT
AROUND
2,370 kg

SAGITTAIREXS XS20 BECASSIER CLASSIQUE

Ref. 242XS20RI60



STEEL SHOT
PROOF TESTED

LIGHTWEIGHT
AROUND
2,370 kg

SAGITTAIREXS XS20 BECASSIER EXTRA-LUXE

Ref. 262XS20RI60

> Specifications

- CALIBER: Magnum 20 gauge
- TOTAL LENGTH: XS20 Plaine 115 cm
XS20 Becassier 104 cm
- WEIGHT: XS20 Plaine 2,600 kg
XS20 Becassier 2,370 kg
- BARRELS XS20 PLAINE:
 - 71 cm Chrome molybdenum cold-forged «super diamond» steel
 - Interchangeable chokes, 20 gauge
- BARRELS XS20 BECASSIER:
 - 60 cm Chrome molybdenum cold-forged «super diamond» steel
 - Lower barrel with Verney-Carron extra spread rifling and upper barrel with interchangeable chokes Chokinox®

- TRIGGER: double with dual-action front TRIGGER
- LOCKING: by 2 conical bolts
- RECEIVER: Ergal (steel on request for XS20 PLAINE)
- WOOD: oil-finished walnut
 - STOCK : pistol grip (or English at extra charge)
 - Forend : full
- EJECTION: extractor or automatic ejectors (on request and at extra charge for xs20 becassier)
- SIGHTING SYSTEM: 7mm ventilated rib
- PERCUSSION: axial and direct
- SLING SWIVELS: supplied

> Options

- XS20 Plaine Magnum 20 gauge with 66 cm barrels and 28 gauge with 71 cm barrels models are available on request
- English stock available at extra charge
- Custom stock measurements on request
- Genuine left-handed
 - Left opening key
 - Modified stock for left-handed
- Interchangeable 20 gauge choke
- «Série spéciale» wood ★★★★★ and handmade engraving on request
- Additional set of barrels
- Custom possibilities:
 - your name on the barrel
 - your initials on the trigger guard



YOU WILL LIKE

With the RND®, a non-scatter rifling, your shots will stay clustered and used in conjunction with the appropriate choke, shots will be similar to a smoothbore shotgun.

The action is produced according to Verney-Carron requirements and specifications. The barrel is made in our workshop in Saint-Etienne – FRANCE.



STEEL SHOT
PROOF TESTED

PUMP ACTION SHOTGUN P12 BLACKCROW
RND® (non-scatter rifling) system
Magnum 12 Ga
71 cm or 76 cm barrel with interchangeable chokes
Supplied with 3 interchangeable chokes
Ref. P12RCX71 or P12RCX76

> Options :

- Interchangeable chokes
- Additional barrels:
 - Blackcrow, RND system, 71 cm or 76 cm
 - Gros Gibier, Hastings® Paradox® rifling.

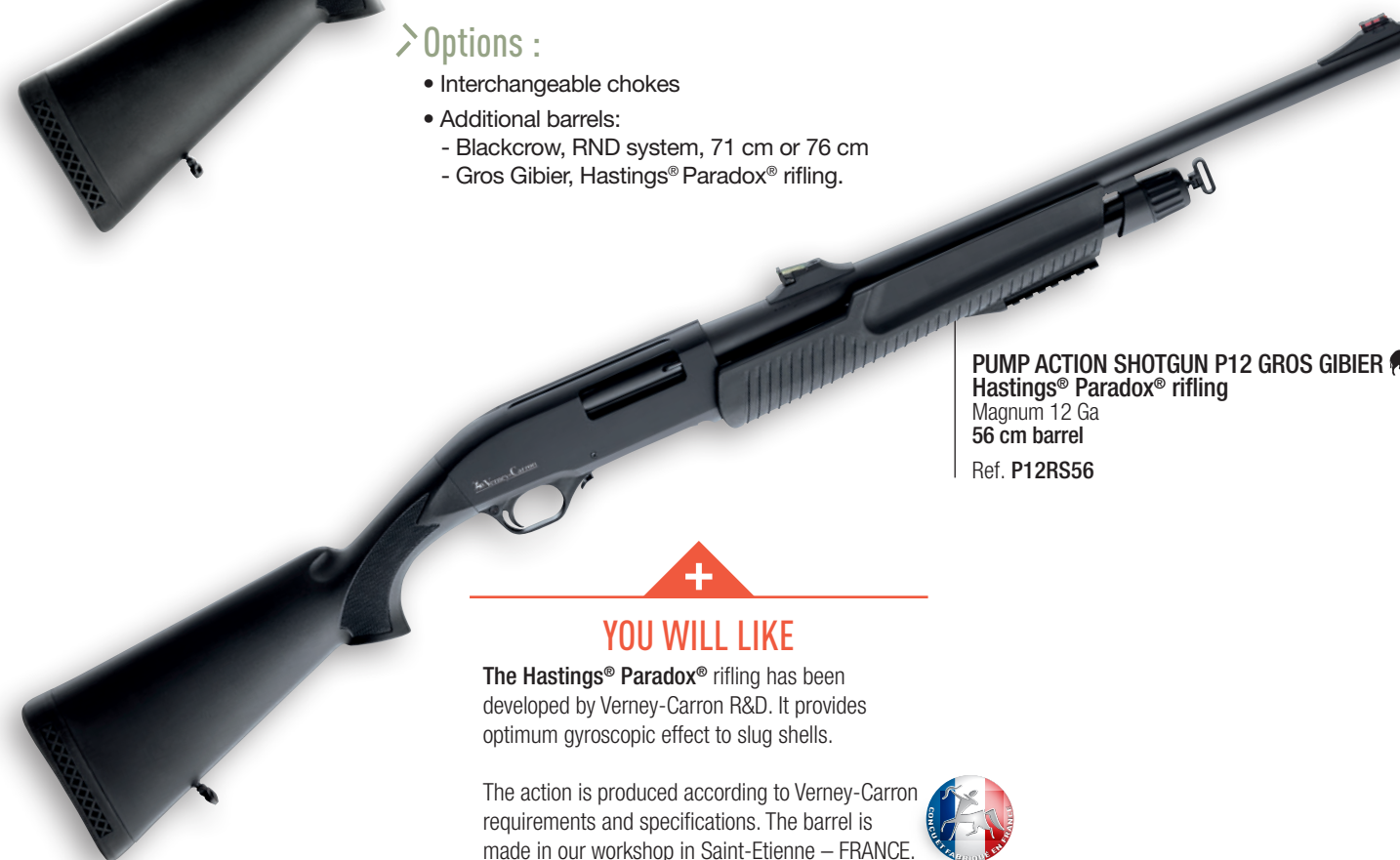

PUMP ACTION SHOTGUN P12 GROS GIBIER
Hastings® Paradox® rifling
Magnum 12 Ga
56 cm barrel
Ref. P12RS56



YOU WILL LIKE

The Hastings® Paradox® rifling has been developed by Verney-Carron R&D. It provides optimum gyroscopic effect to slug shells.

The action is produced according to Verney-Carron requirements and specifications. The barrel is made in our workshop in Saint-Etienne – FRANCE.





MATRIX « PLAINE »
 71 cm barrel, total length 125 cm, Magnum 12 gauge,
 Ergal receiver, ventilated rib 7 mm, interchangeable chokes
 (supplied with 3 chokes: cylinder, ½ and full)
 Steel shot proof tested.
 Ref. **MATB12CX71** (Wooden stock)
 Ref. **MATS12CX71** (Synthetic stock)



MATRIX « GIBIER D'EAU »
 76 cm barrel, total length 130 cm, Magnum 12 gauge,
 Ergal receiver, ventilated rib 7 mm, interchangeable chokes
 (supplied with 3 chokes: cylinder, ½ and full)
 Steel shot proof tested.
 Ref. **MATB12CX76** (Wooden stock)
 Ref. **MATS12CX76** (Synthetic stock)



MATRIX BECASSIER
 61 cm barrel, total length 114 cm, Magnum 12 gauge,
 Ergal receiver, ventilated rib 7 mm, interchangeable chokes
 (supplied with 3 chokes: cylinder, ½ and full)
 Steel shot proof tested.
 Ref. **MATB12C60B** (Wooden stock)



MATRIX GROS GIBIER 12 
 61 cm barrel, total length 114 cm, Magnum 12 gauge,
 Ergal receiver, cylinder fixed choke, rear sight and front
 sight.
 Ref. **MATB12C60S** (Wooden stock)



V12N
 Magnum 12 gauge



V12N « PLAINE » :
 71 cm barrel, total length 123 cm, supplied with 3 interchangeable chokes,
 ventilated rib 7 mm. Steel shot proof tested.
 Ref. **V12NCX71** (Wooden stock)
 Ref. **V12NSCX71** (Synthetic stock)
 Ref. **V12NCX71G** (Wooden stock – left-handed model)
V12N « GROS GIBIER 12 » :
 61 cm barrel, total length 113 cm,
 cylinder fixed chokes, battue rib
 Ref. **V12NSB61** (Wooden stock)

V12N « SOUS-BOIS » :
 66 cm barrel, total length 118 cm, supplied with 3 interchangeable chokes,
 ventilated rib 7 mm. Steel proof tested.
 Ref. **V12NCX66** (Wooden stock)
V12N « GIBIER D'EAU » :
 76 cm barrel, total length 128 cm, supplied with 3 interchangeable chokes,
 ventilated rib 7 mm. Steel shot proof tested.
 Ref. **V12NCX76** (Wooden stock)
 Ref. **V12NSCX76** (Synthetic stock)



Stock in ★★★
 walnut



V20N
 Magnum 20 gauge
 71 cm barrel, total length 123 cm, supplied with
 5 interchangeable chokes, ventilated rib 7 mm,
 weight 2,650kg. Steel shot proof tested.
 Ref. **V20NCX71** (Wooden stock ★★★)



V28N
 28 gauge
 71 cm barrel, total length 123 cm, supplied with
 5 interchangeable chokes, ventilated rib 6 mm, weight 2,600 kg.
 Ref. **V28NCX71** (Wooden stock)



YOU WILL LIKE

- Inertia system
- Minimum maintenance for maximum performance
- Ergal receiver
- A well-designed shotgun, excellent handling, and serious workmanship at an attractive price!

Options

- Interchangeable chokes
- extension + 10 cm



- Additional sets of barrels Gros Gibier 12, Plaine and Gibier d'eau (cannot be mounted on Matrix Becassier)



YOU WILL LIKE

- Gas intake system in stainless steel and aluminium. Easy to maintain, the piston includes an all-metal sealing segment for greater reliability. Works with cartridges from 28g to 52g.
- High resistance Ergal receiver, milled for easy fitting of optics.
- Adjustable drop thanks to the 4 plates supplied with the gun
- Magazine cut-off

Options

- Interchangeable chokes, 12, 20 and 28 gauge
- Additional sets of barrels on V12N:
 - Gros Gibier
 - Sous-Bois, Plaine & Gibier d'Eau



SOLO, never hunt alone !

+
YOU WILL LIKE
Extremely safe thanks to the external hammer and large safety catch.



SOLO 410
Breach loading single barrel shotgun, 410 gauge, **71 cm barrel**, total length 110 cm, cocking by external hammers, steel receiver, synthetic stock and forend, with ejectors, black anti-glare finishing. Weight : 2,5 kg
Ref. **SOLOC410**



SOLO 410SI
Breach loading single barrel shotgun with sound moderator, 410 gauge, **80 cm barrel**, total length 119 cm, cocking by external hammers, steel receiver, synthetic stock and forend, with ejectors, black anti-glare finishing. Weight : 2,5 kg.
Ref. **SOLOC410SI**



+
YOU WILL LIKE
It is possible to shoot, shot by shot **or two shots at once.**

NEW



SIDE-BY-SIDE VERCAR CANARDOUZE 12 GA SUPER MAGNUM
This side-by-side shotgun will be the perfect companion for waterfowl hunting from blinds. It has 81cm barrels with interchangeable chokes (supplied with 4 chokes), steel receiver, Super Magnum 12 Ga (=12/89), weight about 5.500 kg, pistol stock, integrated anti-recoil system, extractor, steel shot proof tested.
Supplied with adaptor for waterfowl scope.
Supplied with a case and 4 interchangeable chokes: 2 x 1/2 and 2 x full.
Ref. **CHJ12VERCAR81CX**



JUXTAPOSE VERCAR®
Solid and reliable, this side by side Vercar has **71cm barrels** with interchangeable chokes (supplied with 3 chokes), pistol grip stock, steel receiver, steel shot proof tested (except 28 gauge and 410 gauge), selective single trigger, extractor.
Ref. **CHJ12VERCAR71CX** ((Magnum 12 gauge - around 2,750 kg)
Ref. **CHJ20VERCAR71CX** (Magnum 20 gauge - around 2,650 kg)
Ref. **CHJ28VERCAR71CX** (28 gauge - around 2,500 kg)
Ref. **CHJ410VERCAR71CX** (410 gauge - around 2,100 kg) **NEW**

Air rifles **VCR**



SYNTHETIC AIR RIFLE
Air rifle with muzzle break and fiber optic front sight. Polymer stock. Caliber: 4,5 mm. Total length: 115 cm. Barrel length: 45 cm. Velocity: 268 m/s. Energy: 19,9 Joules
Weight: 2,9 kg
Ref. **AIR45S19**



SYNTHETIC RIFLE THUMBHOLE STOCK
Air rifle with muzzle break and fiber optic front sight. Polymer thumbhole stock. Caliber: 4,5 mm. Total length: 115 cm. Barrel length: 45 cm. Velocity: 268 m/s. Energy: 19,9 Joules
Weight: 2,9 kg
Ref. **AIR45STP19**

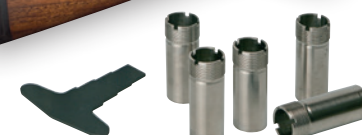

(supplied with 5 chokes and choke spanner for fast fitting and removal)



SUPERPOSE VERCAR®
This Vercar over and under shotgun has **71cm barrels** with interchangeable chokes (supplied with 5 chokes), grey steel receiver, pistol grip stock, selective single trigger, extractor and steel shot proof tested (except 28 gauge and 410 gauge).
Ref. **CHVERCAR71CX** (Magnum 12 gauge - around 3,100 kg)
Ref. **CH20VERCAR71CX** (Magnum 20 gauge - around 2,800 kg)
Ref. **CH28VERCAR71CX** (28 gauge - around 2,600 kg)
Ref. **CH410VERCAR71CX** (410 gauge - around 2,600 kg) **NEW**

Express Safari du Sourou
Tested and available at «Express Safari du Sourou» hunting camp in Burkina Faso.
Contact: +33 660 88 99 01



SUPERPOSE VERCAR® GROS GIBIER 12
It has **55cm barrels** with cylindrical fixed chokes, grey steel receiver, weight around 2,750 kg, Magnum 12 gauge, pistol stock, selective single trigger, extractor.
Ref. **CHVERCAR55CC**



SUPERPOSE VERCAR® TRAP 12
Grey steel receiver, automatic ejectors, **76cm barrels** with interchangeable chokes (supplied with 5 chokes), Magnum 12 gauge, weight around 3,6 kg, high ventilated rib (10mm) with fiber optic front sight, single selective trigger, oil-finished Monte-Carlo pistol stock 370 mm length with adjustable comb, drop at comb 38 mm, drop at heel 55 mm, total length 121 cm for this Vercar Trap 12 over and under.
Ref. **CHVERCAR76CXT**



Verney-Carron welcomes you in a New Era...

The SPEEDLINE is neither a bolt action rifle, nor a semi-automatic rifle, nor a linear reloading rifle. **It is a revolutionary rifle!** It's up to you to work the lever!

Stability, ergonomics and comfort for an unequalled rate of fire

Stability : 45 % less recoil thanks to the **Fulgur®** muzzle brake

Ergonomics: optimized grip thanks to exclusive chevron checkering of the stock and the forend.

Comfort: thanks to the **Executive® Stock** (2 adjustable combs and 2 recoil pads. Combs can be adjusted (comb 1 - 0 to 6 mm / comb 2 - 20 to 26 mm), allowing optimal aiming with or without optics. The recoil pads (15 mm and 25 mm) enable the length of pull to be adjusted while effectively minimizing recoil.



System **STOP & GO**

The patented Stop&Go® system allows an unequalled rate of fire on a manual loading rifle, by locking the bolt to the rear after automatic ejection of the fired shells. The reloading is achieved by a light pressure on the lever.



FLUTED BARREL

FULGUR® MUZZLE BREAK

PISTOL GRIP CAPS « SAGITTAIRE » OR PISTOL GRIP CAP « GATOR » ACCORDING MODELS (MORE PISTOL GRIP CAPS, SEE P.26)



SIGHTS: WITH OR WITHOUT BATTUE RIB



More than 100 setups available!

The different accessories provided with this rifle make it extremely versatile, and allow all users to adapt the SPEEDLINE to their personal build and type of hunting.



WITHOUT OPTICS (flat comb ①)

WITH OPTICS (raised comb ②)

Adjustable combs thanks to the 3 plates and 4 settings

RECOIL PADS

EXECUTIVE® STOCK

+
YOU WILL LIKE

- An exceptional modularity with the various included accessories
- An unequalled rate of fire on a hand cocking rifle



Stock in ★★★ walnut

RHP : HIGH PERFORMANCE COATING

LIMITED EDITION NEW

Pistol grip cap « Gator »

« Alligator » deep engraving of a striking reality aspect!

LIGHTWEIGHT AROUND **3,150 kg** (WITHOUT MUZZLE BREAK)

SPEEDLINE GATOR
Limited edition
RHP : high performance coating
« Alligator » deep engraving of a striking reality aspect!
Ref. 85SL



LIGHTWEIGHT AROUND **3,150 kg** (WITHOUT MUZZLE BREAK)

SPEEDLINE
Ref. 83SL

NEW

LIGHTWEIGHT AROUND **3,150 kg** (WITHOUT MUZZLE BREAK)

LEFT-HANDED SPEEDLINE
Ref. 83SLG

Specifications

- CALIBERS: 7x64, 300 Win Mag, 30-06, 7mm Rem Mag
- TOTAL LENGTH: 113 cm
- WEIGHT: 3,150 kg (without muzzle brake)
- BARREL: high-precision barrel, rifled and fluted, 55 cm (without muzzle brake)
- LOCKING: 6 lugs directly into the barrel
- STOCK: walnut, ergonomic checkering and Executive® Stock system.
- RECEIVER: Ergal
- EJECTION: 2 piston ejection system
- SIGHTING SYSTEM: versatile, with either open sights or battue rib

Options

- MAGAZINE: removable metal magazine for 5 cartridges
- SLING SWIVELS: detachable, supplied
- OPTICS: threaded mounting holes in the receiver with steel insert
- Special offer **Optimum®** Pack rail + optic
- Optics, rails and mounts
- Additional 3 shots magazines
- Additional 5 shots magazines
- Custom possibilities:
 - your name or your text on the barrel
 - personalized grip cap
 - Other pistol grip caps see page 26



Supplied with gun case



+

LE PLUS PRODUIT

The quickest linear rifles on the market



LIGHTWEIGHT
AROUND
3,100 kg

IMPACT LA ONE
Synthetic stock and forend
Ref. 33LAS (55 cm barrel)
Ref. 33LATS (47 cm barrel - Traqueur)



LIGHTWEIGHT
AROUND
3,100 kg

IMPACT LA CAMO
Synthetic stock and forend
Ref. 33LASCAMO (55 cm barrel)
Ref. 33LATSCAMO (47 cm barrel - Traqueur)



LIGHTWEIGHT
AROUND
3,150 kg

IMPACT LA CLASSIQUE
Walnut stock and forend.
Ref. 33LA (55 cm barrel)
Ref. 33LAT (47 cm barrel - Traqueur)



LIGHTWEIGHT
AROUND
3,150 kg

IMPACT LA LUXE WOOD
Walnut stock and forend.
Ref. 33LB (55 cm barrel)
Ref. 33LBT (47 cm barrel - Traqueur)

NEW



LIGHTWEIGHT
AROUND
3,150 kg

IMPACT LA BÊTE NOIRE
Walnut stock and forend.
Ref. 33BN (55 cm barrel)
Ref. 33BNT (47 cm barrel - Traqueur)

RHP : HIGH PERFORMANCE COATING

NEW



LIGHTWEIGHT
AROUND
3,150 kg

IMPACT LA FUSION
Walnut stock and forend.
Ref. 33FU (55 cm barrel)
(7x64, 300 Win Mag, 30-06, 7mm Rem Mag calibres only)
Supplied with removable battue rib

Fluted and threaded barrel



LIGHTWEIGHT
AROUND
3,250 kg

IMPACT LA CLASSIQUE TROU DE POUCE
Walnut stock and forend.
Ref. 33LATP (55 cm barrel)
Ref. 33LATTP (47 cm barrel - Traqueur)
Also available
IMPACT LA TROU DE POUCE CAMO
Walnut stock and synthetic forend
Ref. 33LASTPCAMO (55 cm barrel)
Ref. 33LATSTPCAMO (47 cm barrel - Traqueur)



> Specifications

- CALIBERS: 7x64, 300 Win Mag, 9,3x62 (3-shot magazine only), 30-06, 7mm Rem Mag and 308 Win, (243 Win on request).
- TOTAL LENGTH: 107 cm (or Traqueur 102 cm)
- WEIGHT: 3,150 kg (except synthetic stock: 3,100 kg and thumbhole stock: 3,250 kg)
- BARREL: high precision rifled, 52cm battue (or 47cm Traqueur)
- LOCKING: 6 lugs directly into the barrel
- STOCK: synthetic (or walnut for thumbhole stock)
- FOREND: fixed with sliding element
- RECEIVER: Ergal

- EJECTION: 2 piston ejection system
 - SIGHTING SYSTEM: battue rib with adjustable rear sight, adjustable fiber optic front sight
 - MAGAZINE: removable metal magazine for 3 or 5 cartridges (except 9,3 x 62)
 - SLING SWIVELS: detachable, supplied
 - OPTICS: threaded mounting holes in the receiver with steel insert
- These rifles are tested and zeroed using the ammunitions indicated on their magazine.

> Options

- Special offer **Optimum[®]**
Pack rail + optic
- Additional 3-shot magazine
Additional 5-shot magazine
- Affût model (barrel 60cm) on request
- Custom possibilities:
your name on the barrel
- Fulgur muzzle break for Fusion model
- Performance Pack: 55 cm fluted barrel with thread and muzzle break in 7x64, 300 Win Mag, 30-06 and 7mm Rem Mag calibres only.



YOU WILL LIKE



The **Système Technique Anti-Rebond** (Technical Anti-Kickback System) by Verney-Carron, which locks the bolt firmly in place on closure. This feature allows systematic and solid locking without risk of kickback. All Impact NT semi-auto rifles are equipped with this system.



LIGHTWEIGHT
AROUND
3,100 kg

IMPACT NT ONE
Synthetic stock and forend
Ref. 43BASONE (55 cm barrel)
Ref. 43TSONE (47 cm barrel - Traqueur)



LIGHTWEIGHT
AROUND
3,150 kg

IMPACT NT CLASSIQUE
Walnut stock and forend
Ref. 43BAONE (55 cm barrel)
Ref. 43TONE (47 cm barrel - Traqueur)



LIGHTWEIGHT
AROUND
3,100 kg

IMPACT NT CAMO
Synthetic stock and forend
Ref. 43BASCAMO (55 cm barrel)
Ref. 43TSCAMO (47 cm barrel - Traqueur)



LIGHTWEIGHT
AROUND
3,150 kg

IMPACT NT LUXE WOOD
Walnut stock and forend
Ref. 43LB (55 cm barrel)
Ref. 43LBT (47 cm barrel - Traqueur)



LIGHTWEIGHT
AROUND
3,150 kg

IMPACT NT BETE NOIRE
Walnut stock and forend
Ref. 43BN (55 cm barrel)
Ref. 43BNT (47 cm barrel)



LIGHTWEIGHT
AROUND
3,150 kg

IMPACT NT DIAMANT NOIRE
3 stars oiled-finished walnut stock and forend (Model presented).
Ref. 45LBAONE (55 cm barrel)
Selected walnut stock and forend.
Ref. 45BAONE (55 cm barrel)



LIGHTWEIGHT
AROUND
3,250 kg

IMPACT NT TROU DE POUCE CAMO
Synthetic stock and forend
Ref. 43BASTPCAMO (55 cm barrel)
Ref. 43TSTPCAMO (47 cm barrel - Traqueur)
Also available :
IMPACT NT CLASSIQUE TROU DE POUCE
Walnut stock and forend
Ref. 43BATP (55 cm barrel)
Ref. 43TTP (47 cm barrel - Traqueur)

RHP : HIGH PERFORMANCE COATING



LIGHTWEIGHT
AROUND
3,150 kg

IMPACT NT FUSION
Walnut stock and forend
Ref. 43FU (55 cm barrel)
Supplied with removable battue rib

Fluted and threaded barrel



> Specifications

- CALIBERS: 7x64, 300 Win Mag, 7 mm Rem Mag, 30-06,
- TOTAL LENGTH: 107 cm (or Traqueur 102 cm)
- WEIGHT: 3,150 kg (except synthetic stock: 3,100 kg and thumbhole stock: 3,250 kg)
- BARREL: high precision rifled 52 cm, floating (or Traqueur 47cm on request)
- TRIGGER: light with short travel
- LOCKING: 6 lugs directly into the barrel
- STOCK: synthetic (or walnut for thumbhole stock)
- RECEIVER: ERGAL

- EJECTION: 2 piston ejection system
- SIGHTING SYSTEM: battue rib with adjustable rear sight, adjustable fiber optic front sight
- MAGAZINE: pivoting metal magazine for 2 cartridges (or removable 2 or 5 cartridges).
- SLING SWIVELS: detachable, supplied
- OPTICS: threaded mounting holes in the receiver with steel insert

These rifles are tested and zeroed using the ammunitions indicated on their magazine.

> Options

- Special offer **Optimum**[®] Pack rail + optic
- Optics and mountings
- Affût model (barrel 60cm) on request
- Custom possibilities: your name on the barrel
- Fulgur muzzle break for Fusion model
- Performance Pack: 55 cm fluted barrel with thread and muzzle break in 7x64, 300 Win Mag, 30-06 and 7mm Rem Mag calibers only.



YOU WILL LIKE

Sagittaire's proven technology of over-and-under weapon, at reasonable price but made in France and designed for big game hunters.

ALL OUR EXPRESS ONE AND TRAUQUEUR ONE RIFLES COME WITH A CONTROL TARGET

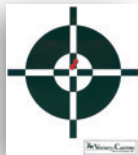

SAGITTAIRE® EXPRESS ONE
Over and under rifle
56 cm barrels.
Total length 100 cm
Ref. 241EXONE



SAGITTAIRE® TRAUQUEUR ONE
Over and under rifle
50 cm barrels.
Total length 94 cm.
Ref. 241EXTONE

Anti-recoil pad for more comfortable shooting



SAGITTAIRE GROS GIBIER ONE
«Slug» over and under shotgun
Gauge 12 Magnum.
Ref. 2420NE56CC

➤ **Common specifications:**

- LOCKING: by 2 conical bolts on the upper barrel
- WOOD: oil-finished walnut
 - Stock: pistol
 - Forend: cased
- RECEIVER: forged Ergal, black anodized
- EJECTION: extractor
- SIGHTING SYSTEM: battue rib and fiber optic front sight
- PERCUSSION: axial and direct
- SLING SWIVELS: supplied

➤ **Express One and Traqueur One specifications:**

- CALIBERS: 8x57 JRS, 9,3x74R
- TOTAL LENGTH: 100 cm or 94 cm (Traqueur One)
- WEIGHT: 3,150 kg or 3 kg (Traqueur One)
- BARRELS: High precision, rifled 56 cm or 50 cm (Traqueur One) Intermediary welded rib
- TRIGGER: non-selective single trigger
- OPTICS: machined slots for mounting

➤ **Gros Gibier One specifications**

- GAUGE: 12 Magnum
- TOTAL LENGTH: 100 cm
- WEIGHT: 2,600 kg
- BARRELS: 56 cm
- CHOKES: Fixed - cylindrical
- TRIGGER: double with first dual action trigger (or single trigger on request)

➤ **Options**

- Special offer **Optimum®** Pack rail + optic
- Custom stock measurements on request
- Stock modified for left-handed (without cheek piece)
- Additional set of barrels (see p. 25)
- Possibility of customization:
 - your name on the barrel
 - your initials on the trigger guard

Combo 1 Sagittaire
SAGITTAIRE Polynox / Bécassier



Ref. COM68CX60RI with extractor

➤ **Specifications**

- Sagittaire Polynox shotgun
- Supplied with a complimentary case
- Bécassier Barrels set:
 - 60 cm barrels
 - Supplied with 2 chokes

➤ **Options**

- See page 7
- Other barrels (see below)

Combo 2 Sagittaire
SAGITTAIRE Express One / Polynox



Ref. COMBEXONE68CX with extractor

➤ **Specifications**

- Sagittaire Express One rifle
- Additional forend for 12 Ga
- Supplied with a complimentary case
- Polynox Barrels set:
 - 68 cm barrels
 - Supplied with 5 chokes

➤ **Options**

- Custom stock measurements on request
- Stock modified for left-handed
- Other barrels (see below)

Additional barrels Sagittaire

SOME SIMPLE RULES TO TAKE INTO ACCOUNT :

- There is no extra cost when an additional barrel is ordered at the same time as the weapon. If a barrel is ordered later, the gun has to be sent back to our workshop for adjustment and mandatory proof testing. Then an extra charge and 2 weeks in our workshop will have to be applied.
- When the gauge/caliber changes it is necessary to buy an additional forend.
- Barrels with extractor could be mounted on a gun with ejectors. The reverse is impossible.
- All smooth bore barrels are chrome plated and made from chrome molybdenum cold-hammered «Super Diamond» steel.

MODEL	LENGTH	RIB	GAUGE	CHOKES	EXTRACTOR	EJECTORS	STEEL SHOT PROOF TESTED	
Aquilon	71 cm	yes - 7 mm	12 Magnum	Supplied with 3 interchangeable Chokes	yes	yes	yes	see p. 6
Polynox®	68 cm	yes - 7 mm	12 Magnum	Supplied with 5 Chokinox®	yes	yes	yes	see p. 7
Bécassier	60 cm	yes - 7 mm	12	Scatter rifling and 2 Chokinox®	yes	yes	yes	-
Bécassier	60 cm	yes - 7 mm	12	Cylindrical and 2 Chokinox®	yes	yes	yes	-
Grand Bécassier	60 cm	no	12	Scatter rifling and 2 Chokinox®	yes	yes	yes	see p. 8
Ultra-Léger	66 cm	no	12 Magnum	Supplied with 3 Chokinox®	yes	yes	yes	see p. 9
Spécial Palombe	76 cm	yes - 11 mm	12 Magnum	3/4 and Extra-full	yes	no	no	see p. 9
La Billebaude	60 cm	yes - 7 mm	12 Magnum	Supplied with 6 Chokinox®	yes	no	yes	see p. 9
Gros Gibier One	56 cm	battue	12 Magnum	Cylindrical	yes	no	on request	see p. 22

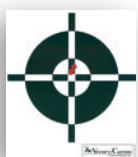

ALL OUR RIFLES
SAGITTAIREXS eXS COME WITH
A CONTROL TARGET



LIGHTWEIGHT
AROUND
3 kg
In caliber 8x57 JRS
Ergal receiver

SAGITTAIREXS eXS CLASSIQUE
Ref. 241XS (extractor)
Ref. 251XS (automatic ejectors)



LIGHTWEIGHT
AROUND
3 kg
In caliber 8x57 JRS
Ergal receiver

SAGITTAIREXS eXS EXTRA-LUXE
Ref. 261XS (extractor)
Ref. 271XS (automatic ejectors)



LIGHTWEIGHT
AROUND
3 kg
In caliber 8x57 JRS
Ergal receiver

SAGITTAIREXS eXS SAINT-HUBERT
Ref. 261XSSH (extractor)
Ref. 271XSSH (automatic ejectors)



YOU WILL LIKE

THE SAGITTAIREXS eXS HAS A GENUINE 20 GAUGE RECEIVER.

(XS = Extra Small), with entirely reworked lines (finer and rounded receiver, modified top lever...).



Specifications

- CALIBERS: 8x57 JRS, 9,3x74R (or 30R Blaser on request)
- TOTAL LENGTH: 100 cm
- WEIGHT: 3 kg (Ergal receiver) or 3,2 kg (steel receiver)
- BARRELS: high precision rifled:
 - 56 cm
 - Intermediary welded rib
 - Micrometric adjustment at barrel ends
- TRIGGERS: non selective single trigger or «classic» double trigger on request
- LOCKING: by 2 conical bolts

- WOOD: oil-finished walnut
 - Stock: pistol grip with cheek piece. For left handed (without cheek piece) in option.
 - Forend: full tulip forend
- RECEIVER: size "20 gauge" in high resistance forged steel (or forged Ergal in 8x57 JRS)
- EJECTION: extractor or automatic ejectors with extremely powerful hammers
- SIGHTING SYSTEM: battue rib with 3-point rear sight, fiber optic front sight
- OPTICS: machined slots for mounting
- PERCUSSION: axial and direct
- SLING SWIVELS: supplied

Options

- Custom stock measurements on request
- Genuine left-handed:
 - Left-opening top lever
 - Stock modified for left-handed (without cheek piece)
- Pistol grip stock and rear safety
- Optics and mountings
- Additional set of barrels
- Custom possibilities:
 - your name on the barrel
 - your initials on the trigger guard

Combo 1 SagittaireXS
SAGITTAIREXS XS20 Plaine / XS20 Bécassier

Special offers



Ref. COMBXS20 with extractor

Specifications

- Shotgun SagittaireXS20 Plaine :
- Supplied with a complimentary case
- XS20 Bécassier Barrels set:
- 60 cm barrels
 - Supplied with 2 chokes

Options

- See page 10
- Other barrels (see below)

Combo 2 SagittaireXS
SAGITTAIREXS eXS Finition Classique / XS20 Plaine



Ref. COMBEXONE68CX with extractor

Specifications

- SagittaireXS eXS rifle
- Additional forend
- Supplied with a complimentary case
- SagittaireXS XS20 Plaine Barrels set:
- 71 cm barrels
 - Supplied with 3 interchangeable Chokes

Options

- See page 23
- Other barrels (see below)

Additional barrels SagittaireXS

SOME SIMPLE RULES TO TAKE INTO ACCOUNT :

- There is no extra cost when an additional barrel is ordered at the same time as the weapon. If a barrel is ordered later, the gun has to be sent back to our workshop for adjustment and mandatory proof testing. Then an extra charge and 2 weeks in our workshop will have to be applied.
- When the gauge/caliber changes it is necessary to buy an additional forend.
- Barrels with extractor could be mounted on a gun with ejectors. The reverse is impossible.
- All smooth bore barrels are chrome plated and made from chrome molybdenum cold-hammered «Super Diamond» steel.

MODEL	LONG.	RIB	GAUGE	CHOKES	EXTRACTOR	EJECTORS	STEEL SHOT PROOF TESTED	
XS20 Bécassier	60 cm	yes - 7 mm	20 Magnum	Scatter rifling and 2 interchangeable Chokes	yes	yes	yes	see p. 10
XS20 Plaine	71 cm	yes - 7 mm	20 Magnum	Supplied with 3 interchangeable Chokes	yes	yes	yes	see p. 10
XS20 Sous-Bois	66 cm	yes - 7 mm	20 Magnum	Supplied with 3 interchangeable Chokes	yes	yes	yes	on request
XS28	71 cm	yes - 7 mm	28	Supplied with 3 interchangeable Chokes	yes	no	no	on request



OPTIMUM® PIVOTING MOUNTS

Diameters	For rifles LA, NT and Speedline				For over and under rifles (Express)			
	ø 26		ø 30		ø 26		ø 30	
Models	EAW	OPTAMIT	EAW	OPTAMIT	EAW	OPTAMIT	EAW	OPTAMIT
References	OMPC03	OMPC06	OMPC04	OMPC05	OMPE03	OMPE06	OMPE04	OMPE05



Rail Weaver Ergal **Optimum®**
 Ref. **ORWEL01** - For Impact NT, Impact LA and Speedline
 Ref. **ORWEE02** - For Express/Sagittaire
 Ref. **ORWXS02** - For Express/Sagittaire eXS

HOW TO CHOOSE YOUR COMB

With a comb, the eye is perfectly in the axis of the optic, the head is standing straight and the eyes are totally open. Made of wood; plastic spacers and a rubber plate to be mounted on the stock.



Comb kit for straight stock **Optimum®**
 Ref. **OBED01**

Comb kit for backhog stock **Optimum®**
 Ref. **OBEC01**

CHOOSE YOUR PISTOL GRIP CAP: by Le Baillif, luxury metal or personalized

Pistol grip cap by Le Baillif

Ref. CALLBSAN

Ref. CALLBCHÉ

Ref. CALLBBEC

Ref. CALLBCAN

Pistol grip cap luxury metal

Ref. CALNOSAN

Ref. CALNOCHE

Ref. CALNOBEC

Ref. CALNOCAN

Customized Pistol grip cap

Your initials
HERE

Ref. CALPE

OPTIMUM® RED DOT SIGHT



OPTIMUM red dot sight with projected reticle the most compact of the range. Unlimited field of vision for ultra fast aiming. Red dot sight 3 MOA with automatic adjustment of brightness according to the environment. Direct mount on rail Weaver. Magnification : 1x. Dimensions : 45x22x16mm. Weight : 90g
 Ref. **OPRCD19**



OPTIMUM red dot sight with tubular projected reticle, perfect for battue hunting. Red dot sight 3 MOA with 7 brightness levels to be used in every case. Aluminium mono block body for greater resistance. Direct mount on rail Weaver. Supplied with lens caps for protection. Magnification : 1x. Dimensions : 62x46x43mm. Weight 120 g
 Ref. **OPRCD13**



The OPTIMUM red dot sight Grand Ecran with projected reticle offers you all advantages of the red dot optimum sight: lightness, compactness and wide field of vision. Magnification 1x. Objective width 33mm. Field of view at 100m : 15.7 m. Length 8.2 cm / weight 112 g
 Ref. **OPRGE01**



multi-reticules

TELESCOPIC SIGHT OPTIMUM® PACK

Luger/Optimum Battue
 Magnification : 1-4x.
 Ø Objective : 26 mm
 Ø Tube : 30 mm.
 Reticle : 4A+LP
 Waterproof : yes
 Twilight factor : 5.09 - 10.09
 Weight : 450 g
 Length : 245 mm
 Ref. : **OLBA14X26**

Luger/Optimum Affût
 Magnification : 3-12x.
 Ø Objective : 56 mm
 Ø Tube : 30 mm.
 Reticle : 4A+LP
 Waterproof : yes
 Twilight factor : 12.96 - 25.92
 Weight : 690g
 Length : 350 mm
 Ref. : **OLAF312X56**

Verney-Carron/Dozorme Knives



Thiers Liner, light olive wood handle, black blade. Ref. : 1.90.142.89N-VC.



Thiers Liner, light olive wood handle, steel blade. Ref. : 1.90.142.89-VC.



Capucin de nos campagnes. light olive wood handle. Ref. : 1.94.151.89-VC.



Thiers Liner, dark vallerian wood, black blade. Ref. : 1.90.142.55N-VC.



Thiers Liner, black with corkscrew, black blade. Ref. : 1.90.129.53N-VC.

Wildsteer Tactical knives



WILD-TECH 4
Ref : VCSWDT

WILD-TECH 4 XL :
Ref : VCSWDT3



WING-TACTIC
Ref : VCSWDTM



LIMITED EDITION - WING-TACTIC GIGN
Réf : VCSWDTMGIGN

HUNT WITH VERNEY-CARRON :



L'Atelier Verney-Carron
Bespoke shotguns and rifles
+33 4 77 81 01 21
www.l.atelier.verney-carron.fr



Verney-Carron

La Manufacture Verney-Carron
Hunting shotguns and rifles
+33 4 77 79 15 00
www.verney-carron.fr



www.facebook.com/VerneyCarron



Ligne Verney-Carron (CILVC)
Hunting clothes and accessories
+33 2 38 43 43 58
www.ligne.verney-carron.fr